

FIXING, FASTENING AND SUPPORT PRODUCTS

FEATURED PRODUCTS

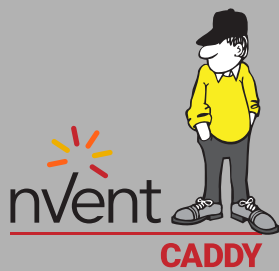

115 Standard Duty Loop Hanger

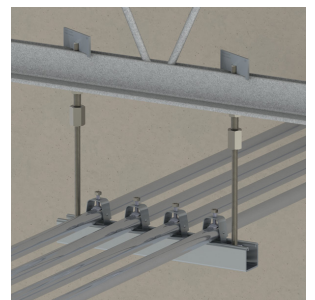
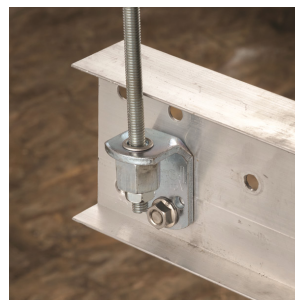
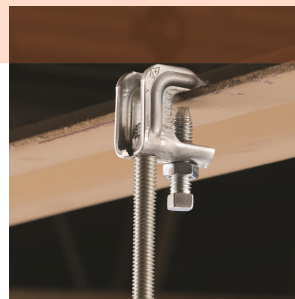
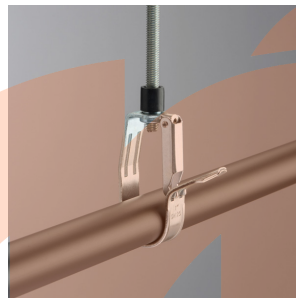

The 115 Standard Duty Loop Hanger is ideal for suspending stationary, non-insulated pipe lines, including CPVC pipes, in fire sprinkler systems. A knurled insert nut helps simplify vertical adjustments and flared edges on the base (1/2" to 4" sizes) help protect pipes from coming into contact with any sharp edges of the hanger.

- Flared edges help prevent any sharp surfaces from coming into contact with the pipe (1/2" to 4" sizes)
- Retained insert nut helps ensure the loop hanger and insert nut stay together
- Recommended for the suspension of stationary non-insulated pipe lines
- Manufactured to use the minimum rod size permitted by NFPA® for fire sprinkler piping
- Conforms with Federal Specification WW-H-171 (Type 10), Manufacturers Standardization Society (MSS) SP-58 (Type 10)

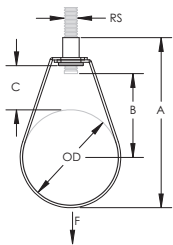

Material: Steel
Finish: Pregalvanized



Part Number	Pipe Size	Outer Diameter OD	Rod Size RS	A	B	C	Static Load F	Certifications
1150050EG	1/2"	0.840"	3/8"	2 13/16"	1 1/8"	1"	300 lb	cULus
1150075EG	3/4"	1.050"	3/8"	3"	1 3/16"	15/16"	300 lb	cULus, FM
1150100EG	1"	1.315"	3/8"	3 1/4"	1 3/8"	15/16"	300 lb	cULus, FM
1150125EG	1 1/4"	1.660"	3/8"	3 9/16"	1 1/2"	15/16"	300 lb	cULus, FM
1150150EG	1 1/2"	1.900"	3/8"	3 13/16"	1 5/8"	15/16"	300 lb	cULus, FM
1150200EG	2"	2.375"	3/8"	4 1/4"	1 7/8"	15/16"	300 lb	cULus, FM
1150250EG	2 1/2"	2.875"	3/8"	5 15/16"	3 7/16"	2"	525 lb	cULus, FM
1150300EG	3"	3.500"	3/8"	6 9/16"	3 1/2"	1 15/16"	525 lb	cULus, FM
1150350EG	3 1/2"	4.000"	3/8"	7 1/16"	3 3/4"	1 15/16"	585 lb	cULus, FM
1150400EG	4"	4.500"	3/8"	7 9/16"	4"	1 15/16"	650 lb	cULus, FM
1150500EG	5"	5.563"	1/2"	9 13/16"	4 3/4"	2 1/4"	1,000 lb	cULus, FM
1150600EG	6"	6.625"	1/2"	11 5/16"	6 5/16"	3 5/16"	1,000 lb	cULus, FM
1150800EG	8"	8.625"	1/2"	12 7/8"	6 7/8"	2 7/8"	1,000 lb	cULus, FM

115 Surge Restraint



- Accommodates multiple sizes of 115 standard duty loop hangers
- Complies with NFPA® 13 standard by restricting the upward surge movement of activated fire sprinkler systems
- Grips the loop hanger, not the nut, allowing fine tuning for height adjustment
- Easily installs by hand before or after pipe is positioned in hanger

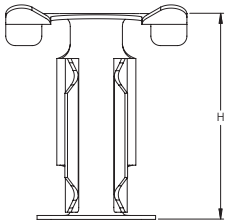

Material: Spring Steel
 Finish: nVent CADDY Armour



Part Number	Pipe Size	Height H
SR6	1/2" - 2"	1.3"

Drop-In Loop Hanger



- Next generation loop hanger revolutionizes the installation of pipe
- Once on the guide arm, the weight of the pipe opens the self-closing latch and effortlessly guides the pipe into place
- Integrated rubber sleeve is designed to provide additional grip when adjusting hanger height and reduce hanger rotation around the barrel nut
- Eliminates the need to disassemble the hanger during installation
- Allows prefabrication of complex assemblies with fittings, sprinkler heads, and branch lines that previously could not be installed in one piece
- Designed to reduce overhead work for a safer, less strenuous installation
- Flared edges help prevent sharp surfaces from coming into contact with the pipe
- Retained insert nut helps ensure the loop hanger and insert nut stay together
- Recommended for the suspension of stationary non-insulated pipe lines
- Manufactured to use the minimum rod size permitted by NFPA® for fire sprinkler piping
- Conforms with Federal Specification WW-H-171 (Type 10), Manufacturers Standardization Society (MSS) SP-58 (Type 10)

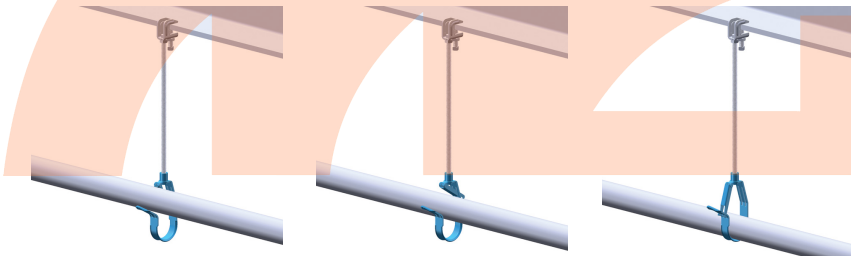
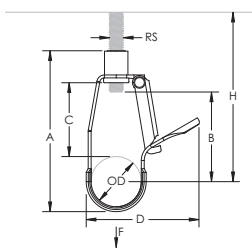

Material: Steel
Finish: Electrogalvanized



Part Number	Pipe Size	Outer Diameter OD	Rod Size RS	A	B	C	D	Installation Height H	Static Load F
DH0100EG	1"	1.315"	3/8"	4 3/8"	2 9/16"	2 3/16"	3"	3 1/2" Min	300 lb
DH0125EG	1 1/4"	1.660"	3/8"	5"	3 1/8"	2 1/2"	3 9/16"	4 1/8" Min	300 lb
DH0150EG	1 1/2"	1.900"	3/8"	5 1/2"	3 7/16"	2 3/4"	3 15/16"	4 3/8" Min	300 lb
DH0200EG	2"	2.375"	3/8"	6 7/16"	4 1/8"	3 1/4"	4 15/16"	5 1/4" Min	300 lb

Installation Height represents the clearance distance needed from the loop hanger guide arm to structure to allow for installation of pipe.

DH Surge Restraint



- Designed to work directly with the Drop-in Loop Hanger series
- Complies with NFPA® 13 standard by restricting the upward surge movement of activated fire sprinkler systems
- Easily installs by hand before or after pipe is positioned in hanger

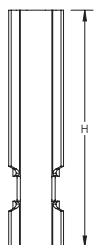

Material: Steel
Finish: Electrogalvanized



Part Number	Pipe Size	Height H
SR0100EG	1"	2.77"
SR0125EG	1 1/4"	3.08"
SR0150EG	1 1/2"	3.30"
SR0200EG	2"	3.85"

401 Clevis Hanger



- Recommended for the suspension of stationary non-insulated pipe lines
- Flared edges help prevent sharp surfaces from coming into contact with the pipe (1/2" to 2" pipe sizes)
- Clevis bottom pivots to allow pipe to be fed from either direction
- Conforms with U.S. Federal Specification WW-H-171 (Type 1), Manufacturers Standardization Society (MSS) SP-58 (Type 1)

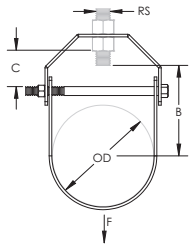

Material: Steel

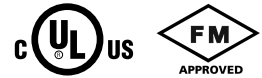

Part Number	Pipe Size	Outer Diameter OD	Rod Size RS	A	B	C	Static Load F	Certifications
Finish: Electrogalvanized, Pregalvanized								
4010050EG	1/2"	0.840"	3/8"	2 5/16"	1 1/8"	3/8"	600 lb	cULus, ITB
4010075EG	3/4"	1.050"	3/8"	2 1/2"	1 1/4"	3/8"	600 lb	cULus, FM, ITB
4010100EG	1"	1.315"	3/8"	2 13/16"	1 3/8"	3/8"	600 lb	cULus, FM, ITB
4010125EG	1 1/4"	1.660"	3/8"	3 1/8"	1 9/16"	3/8"	600 lb	cULus, FM, ITB
4010150EG	1 1/2"	1.900"	3/8"	3 11/16"	2 1/16"	11/16"	600 lb	cULus, FM, ITB
4010200EG	2"	2.375"	3/8"	4 5/16"	2 1/2"	7/8"	600 lb	cULus, FM, ITB
4010250EG	2 1/2"	2.875"	1/2"	5 5/16"	3 1/16"	1"	1,130 lb	cULus, FM, ITB
4010300EG	3"	3.500"	1/2"	6 1/16"	3 1/2"	1 1/8"	1,130 lb	cULus, FM, ITB
4010350EG	3 1/2"	4.000"	1/2"	6 13/16"	4"	1 5/16"	1,130 lb	cULus, FM
4010400EG	4"	4.500"	5/8"	7 7/16"	4 3/8"	1 3/8"	1,130 lb	cULus, FM, ITB
4010500EG	5"	5.563"	5/8"	9 1/16"	5 1/8"	1 5/8"	1,430 lb	cULus, FM, ITB
4010600EG	6"	6.625"	3/4"	10 9/16"	6"	1 7/8"	1,940 lb	cULus, FM, ITB
4010800EG	8"	8.625"	3/4"	14"	8"	3 1/8"	2,000 lb	cULus, FM, ITB
4011000EG	10"	10.750"	7/8"	16 1/2"	9"	2 9/16"	3,600 lb	ITB
4011200EG	12"	12.750"	7/8"	18 5/8"	10 3/16"	3 1/16"	3,800 lb	ITB
4011400EG	14"	14.000"	1"	21 3/4"	12 1/8"	4 3/8"	4,200 lb	ITB
4011600EG	16"	16.000"	1"	24"	13 1/2"	4 5/8"	4,600 lb	ITB
4011800EG	18"	18.000"	1 1/8"	26 3/4"	15"	5 1/8"	4,800 lb	ITB
4012000EG	20"	20.000"	1 1/4"	30"	17"	6"	4,800 lb	ITB
4012400EG	24"	24.000"	1 1/4"	34 1/8"	18 5/8"	5 11/16"	4,800 lb	ITB

Part Number	Pipe Size	Outer Diameter OD	Rod Size RS	A	B	C	Static Load F	Certifications
Finish: Hot-Dip Galvanized								
4010050HD	1/2"	0.840"	3/8"	2 1/8"	15/16"	1/4"	600 lb	cULus
4010075HD	3/4"	1.050"	3/8"	2 3/8"	1 1/16"	3/8"	600 lb	cULus, FM
4010100HD	1"	1.315"	3/8"	2 13/16"	1 3/8"	9/16"	600 lb	cULus, FM
4010125HD	1 1/4"	1.660"	3/8"	3 5/16"	1 3/4"	11/16"	600 lb	cULus, FM
4010150HD	1 1/2"	1.900"	3/8"	4"	2 1/4"	1 1/16"	600 lb	cULus, FM
4010200HD	2"	2.375"	3/8"	4 1/2"	2 9/16"	1 1/8"	600 lb	cULus, FM
4010250HD	2 1/2"	2.875"	1/2"	5 1/4"	2 13/16"	1 1/16"	1,130 lb	cULus, FM
4010300HD	3"	3.500"	1/2"	6"	3 1/4"	7/8"	1,130 lb	cULus, FM
4010400HD	4"	4.500"	5/8"	7 3/4"	4 1/4"	1 3/4"	1,130 lb	cULus, FM
4010500HD	5"	5.563"	5/8"	9 3/4"	5 11/16"	2 3/16"	1,430 lb	cULus, FM
4010600HD	6"	6.625"	3/4"	11 3/4"	6 7/8"	2 11/16"	1,940 lb	cULus, FM
4010800HD	8"	8.625"	3/4"	14"	8 1/8"	3 1/8"	2,000 lb	cULus, FM
4011000HD	10"	10.750"	7/8"	16 1/2"	9 1/16"	2 9/16"	3,600 lb	-
4011200HD	12"	12.750"	7/8"	18 5/8"	10 3/16"	3 1/16"	3,800 lb	-

A shield is recommended for insulated pipe applications to effectively distribute the load.



nVent CADDY Macrofix Plus NI EZ with Easy Closure

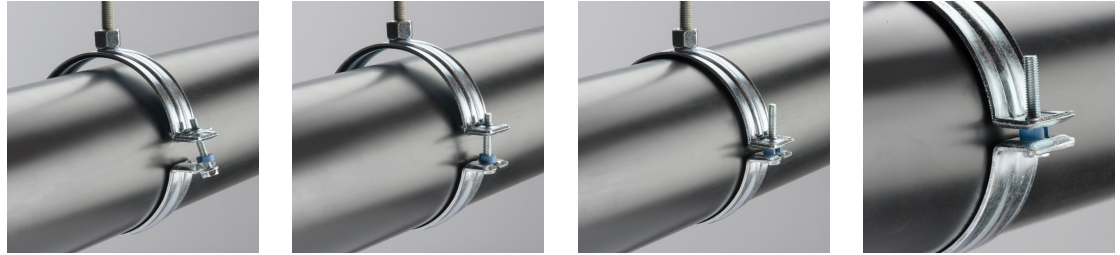
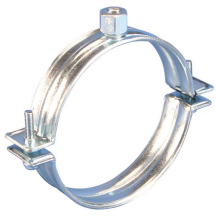

- Contains easy closing mechanism
- Plastic washers help prevent crushing the CPVC or plastic pipe and assure a floating fit
- Flared edges and specially designed welding area help protect CPVC piping
- Suitable for 3/4" - 2" (20 - 50 DN) steel sprinkler pipe
- Combo head bolt works with slotted, hex, or Phillips drivers
- Conforms with Manufacturers Standardization Society (MSS) SP-58 (Type 12)

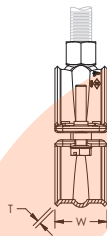
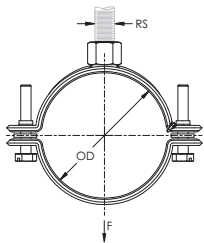

Material: Steel
Finish: Electrogalvanized

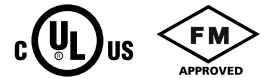

Part Number	Pipe Size	Outer Diameter OD	Rod Size RS	Width W	Thickness T	Static Load F	Certifications
4290050EG	1/2"	0.787" - 0.840"	3/8"	1 3/16"	1/16"	250 lb	cULus
4290075EG	3/4"	0.984" - 1.059"	3/8"	1 3/16"	1/16"	250 lb	cULus, FM
4290100EG	1"	1.260" - 1.327"	3/8"	1 3/16"	1/16"	250 lb	cULus, FM
4290125EG	1 1/4"	1.575" - 1.669"	3/8"	1 3/16"	1/16"	250 lb	cULus, FM
4290150EG	1 1/2"	1.900" - 1.969"	3/8"	1 3/16"	5/64"	320 lb	cULus, FM
4290200EG	2"	2.374" - 2.480"	3/8"	1 3/16"	5/64"	320 lb	cULus, FM
4290250EG	2 1/2"	2.875" - 2.996"	3/8"	1 3/16"	5/64"	320 lb	cULus
4290300EG	3"	3.500" - 3.543"	3/8"	1 3/16"	5/64"	380 lb	cULus
4290350EG	3 1/2"	4.000" - 4.106"	3/8"	1 3/16"	3/32"	440 lb	-
4290400EG	4"	4.331" - 4.500"	3/8"	1 3/16"	3/32"	440 lb	cULus
4290500EG	5"	5.500" - 5.563"	3/8"	1 3/16"	3/32"	440 lb	-

300 Universal Beam Clamp



- Conforms with Federal Specification WW-H-171 (Type 23), Manufacturers Standardization Society ANSI®/MSS-SP-58 (Type 19 and 23)

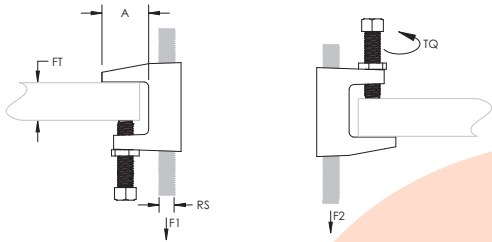

Material: Cast Iron

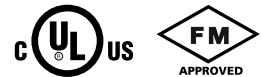

Part Number	Rod Size RS	Flange Thickness FT	A	Torque TQ	Static Load 1 F1	Static Load 2 F2	Certifications	Standard Packaging Quantity
Finish: Plain								
3000037PL	3/8"	3/4" Max	1 1/8"	5 ft lb	500 lb	250 lb	cULus, FM	100 pc
3000050PL	1/2"	3/4" Max	1 1/8"	8 ft lb	950 lb	760 lb	cULus, FM	50 pc
3000062PL	5/8"	3/4" Max	1 1/8"	5 ft lb	950 lb	760 lb	cULus	50 pc
3000075PL	3/4"	3/4" Max	1 1/8"	5 ft lb	950 lb	760 lb	cULus	50 pc
3000087PL	7/8"	3/4" Max	1 1/8"	5 ft lb	950 lb	760 lb	cULus	50 pc
Finish: Electrogalvanized								
3000037EG	3/8"	3/4" Max	1 1/8"	5 ft lb	500 lb	250 lb	cULus, FM	100 pc
3000050EG	1/2"	3/4" Max	1 1/8"	8 ft lb	950 lb	760 lb	cULus, FM	50 pc
3000062EG	5/8"	3/4" Max	1 1/8"	5 ft lb	950 lb	760 lb	cULus	50 pc
3000075EG	3/4"	3/4" Max	1 1/8"	5 ft lb	950 lb	760 lb	cULus	50 pc
3000087EG	7/8"	3/4" Max	1 1/8"	5 ft lb	950 lb	760 lb	cULus	50 pc

Setscrew must be tightened and torqued onto the sloped side of the I-beam.

Recognizing that torque wrenches are generally not used or available on many job sites, the setscrew should be tightened so it contacts the I-beam and then an additional 1/4 to 1/2 turn added.

310 Universal Beam Clamp, Thick Flange



- Universal beam clamp for thick beams
- Conforms with Federal Specification WW-H-171 (Type 23), Manufacturers Standardization Society ANSI®/MSS-SP-58 (Type 19 and 23)

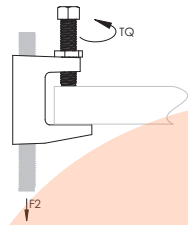
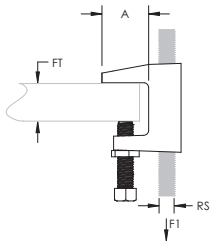

Material: Cast Iron

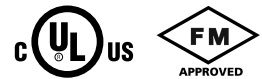

Part Number	Rod Size RS	Flange Thickness FT	A	Torque TQ	Static Load 1 F1	Static Load 2 F2	Standard Packaging Quantity
Finish: Plain							
3100037PL	3/8"	1 1/4" Max	1"	5 ft lb	500 lb	250 lb	50 pc
3100050PL	1/2"	1 1/4" Max	1"	11 ft lb	950 lb	760 lb	50 pc
Finish: Electrogalvanized							
3100037EG	3/8"	1 1/4" Max	1"	5 ft lb	500 lb	250 lb	50 pc
3100050EG	1/2"	1 1/4" Max	1"	11 ft lb	950 lb	760 lb	50 pc

Setscrew must be tightened and torqued onto the sloped side of the I-beam.

Recognizing that torque wrenches are generally not used or available on many job sites, the setscrew should be tightened so it contacts the I-beam and then an additional 1/4 to 1/2 turn added.

SBC Stamped Beam Clamp, Top Mount



- Allows structural attachment to metal beams, bar joist, channel, or angle iron in top mount position only unless used on a parallel flange
- Lightweight, one-piece stamped body provides superior strength and eliminates deficiencies associated with castings
- Spins onto threaded rod and allows for easy adjustment
- Conforms with Federal Specification WW-H-171 (Type 23), Manufacturers Standardization Society ANSI®/MSS-SP-58 (Type 19)

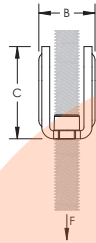
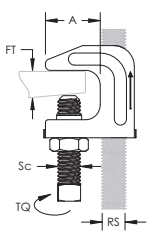

Material: Steel
Finish: Pregalvanized

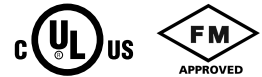

Part Number	Rod Size RS	Flange Thickness FT	A	B	C	Screw Diameter Sc	Torque TQ	Static Load F
SBC037	3/8"	3/4" Max	0.925"	0.85"	1.58"	3/8"	5 ft lb	500 lb

Set screw must be tightened and torqued onto the sloped side of the I-beam, channel, or angle iron flange.

Recognizing that torque wrenches are generally not used or available on many job sites, the setscrew should be tightened so it contacts the I-beam and then an additional 1/4 to 1/2 turn added.

RS Retrofit Retainer Strap



- Ideal for both new and existing applications
- Can be installed without disassembly of the hanging system and/or removing the clamp
- Compatible with all standard nVent CADDY beam clamps and can be secured to either the set screw or threaded rod
- Large teardrop-shaped opening is compatible with multiple threaded rod diameters, reducing inventory by 50%
- Coined edge on teardrop-shaped opening locks into rod, eliminating shifting during install
- Provides a secure attachment in seismic zones and complies with NFPA® requirements
- Meets the UL® load test for retainer straps (3/8" and 1/2" rod sizes)

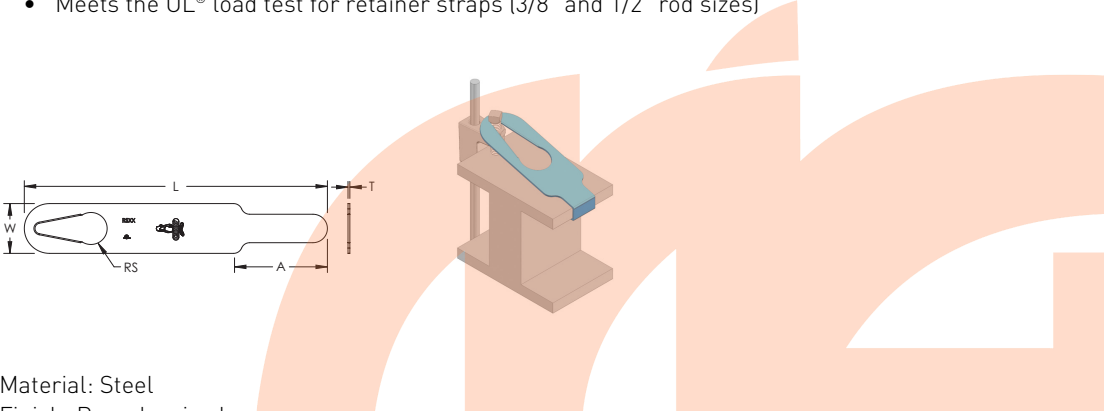

Material: Steel
Finish: Pregalvanized



Part Number	Length L	Width W	Thickness T	Rod Size RS	Hole Size HS	A
RS06	6 1/2"	1 3/4"	16 GA	3/8", 1/2", 5/8", 3/4"	1 1/8"	3 1/4"
RS08	8 1/2"	1 3/4"	16 GA	3/8", 1/2", 5/8", 3/4"	1 1/8"	3 1/4"
RS10	10 1/2"	1 3/4"	16 GA	3/8", 1/2", 5/8", 3/4"	1 1/8"	3 1/4"
RS12	12 1/2"	1 3/4"	16 GA	3/8", 1/2", 5/8", 3/4"	1 1/8"	3 1/4"
RS14	14 1/2"	1 3/4"	16 GA	3/8", 1/2", 5/8", 3/4"	1 1/8"	3 1/4"
RS16	16 1/2"	1 3/4"	16 GA	3/8", 1/2", 5/8", 3/4"	1 1/8"	3 1/4"
RS18	18 1/2"	1 3/4"	16 GA	3/8", 1/2", 5/8", 3/4"	1 1/8"	3 1/4"

Add 2" to width of flange to determine minimum length strap required.



nVent CADDY Rod Lock Beam Clamp

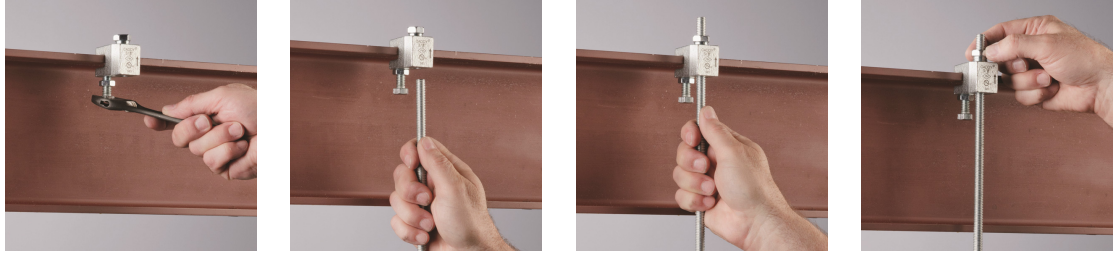
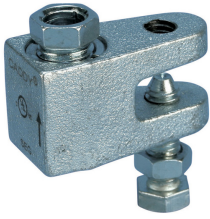

- Prefabricated assemblies easily lift and lock into place, helping to save time and money
- Easy "push-to-install" design allows installers to simply push the threaded rod through the mounting hole, instantly holding it in position
- Lock nut can be finger tightened, locking the rod in place
- Works with slightly damaged threads and minor burrs on the threaded rod
- Conforms with Federal Specification WW-H-171 (Type 23), Manufacturers Standardization Society ANSI®/MSS-SP-58 (Type 19 and 23)

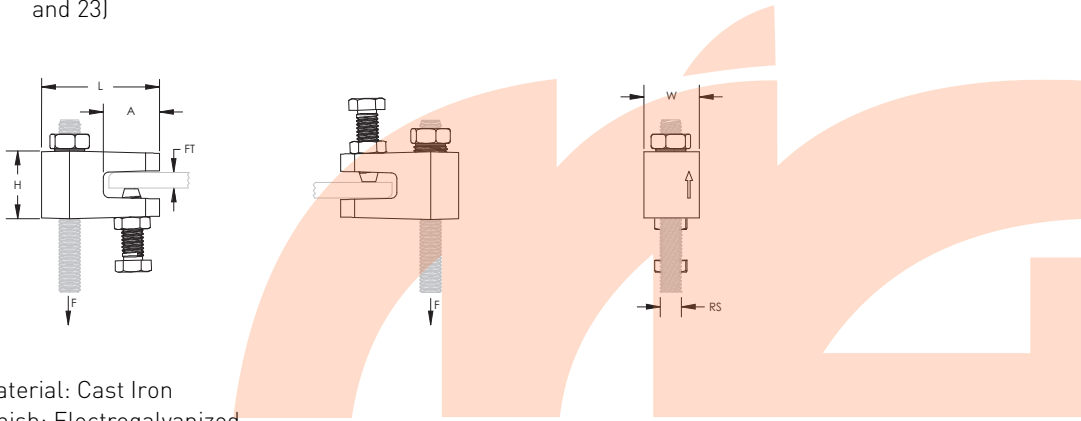

Material: Cast Iron
Finish: Electrogalvanized



Part Number	Rod Size RS	Flange Thickness FT	Height H	Length L	Width W	A	Static Load 1 F1	Static Load 2 F2
CRLB37EG	3/8"	1/8" - 3/8"	1 3/16"	2.06"	1"	0.98"	250 lb	500 lb

For use on plain and electro zinc plated hardware only.

Static Load 1 represents 1/8" to 3/16" (3 mm to 5 mm) flange thickness. Static Load 2 represents 1/4" to 3/8" (6 mm to 10 mm) flange thickness.

Recognizing that torque wrenches are generally not used or available on many job sites, the setscrew should be tightened so it contacts the I-beam and then an additional 1/2 turn added.

nVent CADDY Rod Lock Beam Clamp, Thick Flange



- Prefabricated assemblies easily lift and lock into place, helping to save time and money
- Easy "push-to-install" design allows installers to simply push the threaded rod through the mounting hole, instantly holding it in position
- Lock nut can be finger tightened, locking the rod in place
- Works with slightly damaged threads and minor burrs on the threaded rod
- Conforms with Federal Specification WW-H-171 (Type 23), Manufacturers Standardization Society ANSI®/MSS-SP-58 (Type 19 and 23)

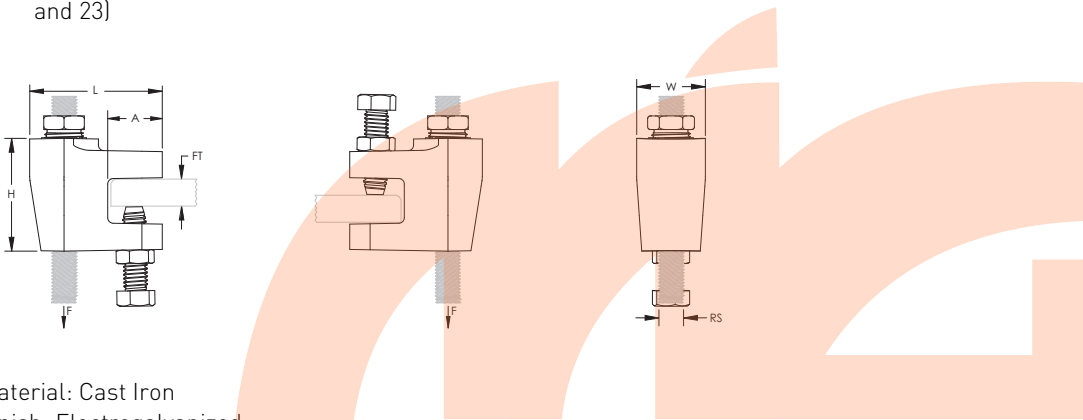

Material: Cast Iron
Finish: Electrogalvanized



Part Number	Rod Size RS	Flange Thickness FT	Height H	Length L	Width W	A	Static Load F
CRLB50EG	1/2"	3/8" - 3/4"	2.1"	2.4"	1.3"	1"	1,100 lb

For use on plain and electro zinc plated hardware only.

FM® Approved in the bottom mount orientation only.

Recognizing that torque wrenches are generally not used or available on many job sites, the setscrew should be tightened so it contacts the I-beam and then an additional 1/2 turn added.

329 Side Beam Attachment



- Supports pipe from wood, concrete or steel structures
- Installs on vertical mounting surface
- Pre-threaded captive nut allows for easy adjustment
- Eliminates the need for additional hardware
- Complies with VdS® CEA 4001 (Guidelines for Sprinkler Systems) Chapter 15.2.3 and shall be installed in accordance with VdS CEA 4001

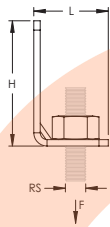
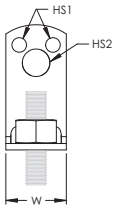

Material: Steel
Finish: Electrogalvanized

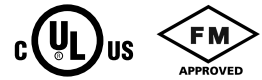

Part Number	Rod Size RS	Hole Size 1 HS1	Hole Size 2 HS2	Height H	Length L	Width W	Static Load F
3290037EG	3/8"	0.276"	0.51"	2.31"	1.1"	1.102"	350 lb

Structure	Fastener Type	Fastener Quantity	UL Nominal Pipe Size	FM Nominal Pipe Size
Wood (Pre-drilling not Required)	#14 x 2" Drive Screw	2	2" Max	3" Max
	1/4" x 1 1/2" Lag Bolt	2	2" Max	3" Max
	1/4" x 2" Lag Bolt	2	2" Max	3 1/2" Max
	3/8" x 3" Lag Bolt, Washer	1	2" Max	3 1/2" Max
Wood (1/4" Pilot Hole Required)	1/2" x 3" Lag Bolt	1	4" Max	4" Max
Steel (Minimum 16 GA)	3/8" Bolt, Washer, Nut	1	4" Max	4" Max
	1/4" x 1" Self Drill & Tap Screw	2	4" Max	4" Max
Concrete	3/8" Bolt	1	4" Max	4" Max

Install in accordance with applicable code.

37 Steel Eye Socket Rod Hanger



- Joins hanger rod to a structure

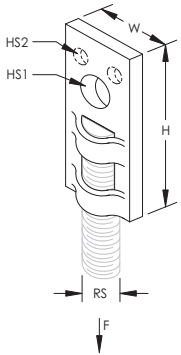

Material: Steel
Finish: Pregalvanized

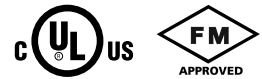

Part Number	Rod Size RS	Pipe Size, FM	Pipe Size, UL	Hole Size 1 HS1	Hole Size 2 HS2	Height H	Width W	Static Load F
0370037EG	3/8"	3/4" - 4"	3/4" - 4"	1/2"	1/4"	2 1/4"	1 1/8"	250 lb
0370050EG	1/2"	2 1/2" - 6"	2 1/2" - 8"	1 1/16"	-	2 3/4"	1 1/2"	760 lb

Load rating dependent on wood structure strength.
FM® Approved for 1/2" rod size when fastened to concrete and steel only.

nVent CADDY Rod Lock L-Bracket

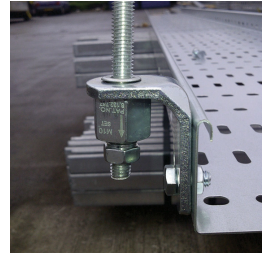
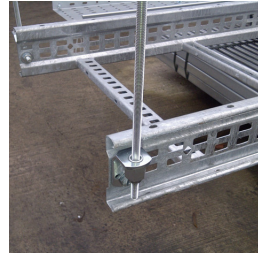
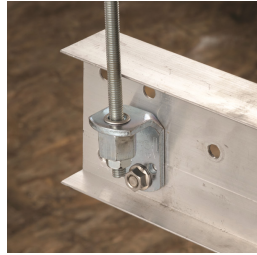

- Easy "push-to-install" design allows installers to simply push the threaded rod through the mounting hole, instantly holding it in position
- Prefabricated assemblies easily lift and lock into place, helping to save time and money
- Multiple attachment holes support the use of either self-drilling screws or bolts, offering installation options for concrete, wood, and steel structures
- Lock nut can be finger tightened, locking the rod in place
- Integrated adjustment nut enables fine tuning the system height up or down
- Extremely useful in tight spaces where wrenches are difficult to use
- Conforms with Federal Specification WW-H-171 (Type 23), Manufacturers Standardization Society ANSI®/MSS-SP-58 (Type 19 and 23)

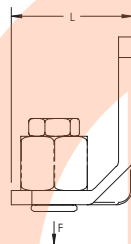
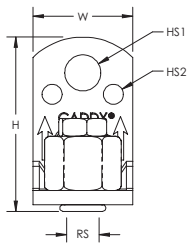

Material: Steel
Finish: Electrogalvanized



Part Number	RS (")	H (")	L (")	W (")	HS1 (")	HS2 (")	Wrench Size (")	F (lb)
CRLL37EG	3/8	2.41	1.7	1.4	0.51	0.28	11/16	700

Follow fastener manufacturer's recommended shear and pull-out strength when fastening to the structure. Fastener not included.
Install in accordance with applicable code.

HangerMate® Horizontal Mount Screw for Steel with Lock Nut



- Convenient design allows fast and easy installation
- Eliminates the need for labor-intensive operations, such as pre-punching or drilling of steel components
- Only one driver needed for all anchor sizes
- Cross-drilled and tapped head permits horizontal mounting of threaded rod systems

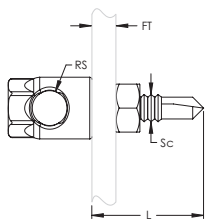

Material: Steel
 Finish: Electrogalvanized

Part Number	Rod Size RS	Flange Thickness FT	Screw Diameter Sc	Screw Length L
HMZH476	3/8"	0.06" – 0.25"	1/4"	1"

nVent CADDY Truss-T Bar Joist Hanger, Bottom Chord

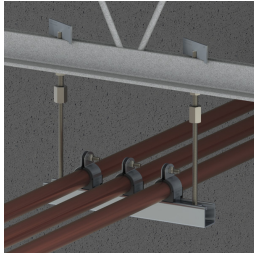
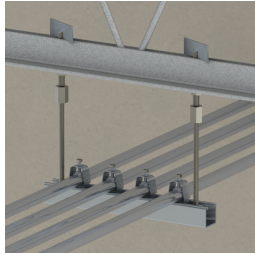

- Easily installs on the bottom chord of engineered open web bar joists from underneath, limiting overhead work
- Innovative attachment effortlessly slides through the middle slot of open web bar joists and quickly locks into place when put under load
- Installation of the complete, self-contained system can be accomplished with one hand and requires no additional special tools
- The unique design of the nVent CADDY Truss-T hanger does not need to be tightened like a traditional beam clamp, providing greater adjustability and speed during system alignment
- Prefabricated single pipe hanger and multi-pipe/tube trapeze assemblies can be prefabricated on the ground or in the shop, and easily hung by the installer
- Concentric loading the bar joist chord eliminates torsion and/or distortion, adhering to the strict rules established by the Steel Joist Institute (SJI)
- The increased load carrying capacity results in the product being UL listed to support a maximum of 8" Schedule 40 pipe
- Made in the USA

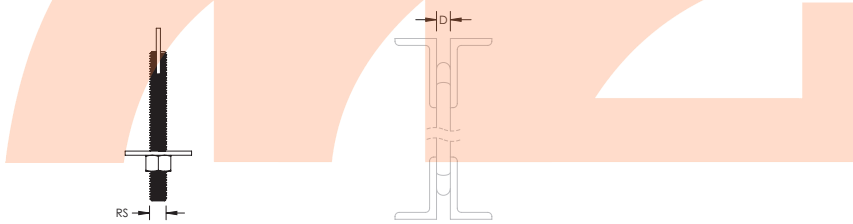
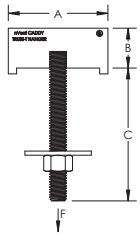

Material: Steel
 Finish: Pregalvanized
 Static Load Safety Factor: 3.5:1



Part Number	Rod Size RS	A	B	C	D	Static Load F
CTH037BC	3/8"	3"	1 1/4"	4 1/2"	1/2" - 1"	1,200 lb
CTH050BC	1/2"	3"	1 1/4"	4 1/2"	1/2" - 1"	1,200 lb

nVent CADDY Truss-T Bar Joist Hanger, Top Chord

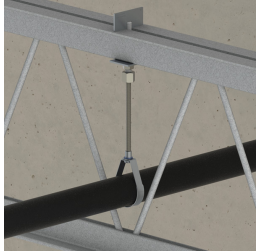
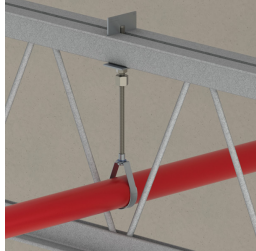

- Easily installs on the top chord of engineered open web bar joists from underneath, limiting overhead work
- Innovative attachment effortlessly slides through the middle slot of open web bar joists and quickly locks into place when put under load
- Installation of the complete, self-contained system can be accomplished with one hand and requires no additional special tools
- The unique design of the nVent CADDY Truss-T hanger does not need to be tightened like a traditional beam clamp, providing greater adjustability and speed during system alignment
- Prefabricated single pipe hanger and multi-pipe/tube trapeze assemblies can be prefabricated on the ground or in the shop, and easily hung by the installer
- Concentric loading the bar joist chord eliminates torsion and/or distortion, adhering to the strict rules established by the Steel Joist Institute (SJI)
- The increased load carrying capacity results in the product being UL listed to support a maximum of 8" Schedule 40 pipe
- Made in the USA

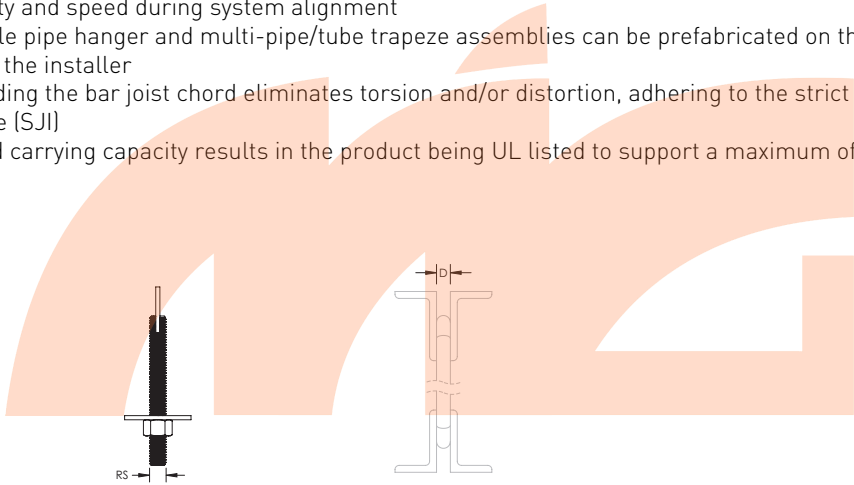
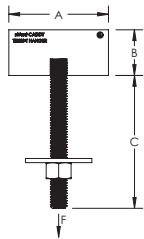

Material: Steel
 Finish: Pregalvanized
 Static Load Safety Factor: 3.5:1



Part Number	Rod Size RS	A	B	C	D	Static Load F
CTH037TC	3/8"	3"	1 3/8"	4 1/2"	1/2" - 1"	1,200 lb
CTH050TC	1/2"	3"	1 3/8"	4 1/2"	1/2" - 1"	1,200 lb

Drop-In Anchor



- Internal thread provides easy removal and serviceability
- Installs flush or below the base surface

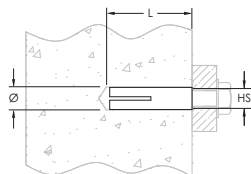

Material: Steel
Finish: Electrogalvanized

Part Number	Hole Size HS	Length L	Diameter Ø
CA0025EG	1/4"	1"	3/8"
CA0037EG	3/8"	1 9/16"	1/2"
CA0050EG	1/2"	2"	5/8"

nVent CADDY Rod Lock Anchor Screw



- For use with concrete and solid brick
- Prefabricated assemblies easily lift and lock into place, helping to save time and money
- Works with slightly damaged threads and minor burrs on the threaded rod

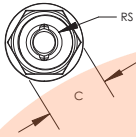
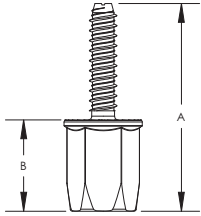

Material: Steel
Finish: Electrogalvanized



Part Number	Rod Size RS	A	B	C	Drill Bit Diameter	Drill Hole Depth	Static Load F	Standard Packaging Quantity
CRLA37EG	3/8"	2 7/8"	1 1/4"	7/8"	5/16"	2"	652 lb	25 pc
CRLA37EGR2	3/8"	2 7/8"	1 1/4"	7/8"	5/16"	2"	652 lb	20 x 2 pc

For use on plain and electro zinc plated hardware only.
Tested in 3,000 psi (20.68 MPa) concrete and soft or hard wood with a 9/32" pilot hole.

nVent CADDY Rod Lock Anchor Screw Drive Socket



- Drive socket for quick installation of nVent CADDY Rod Lock Anchor Screw

Material: Steel

Part Number	Socket Width
CRLAKITA	22 mm

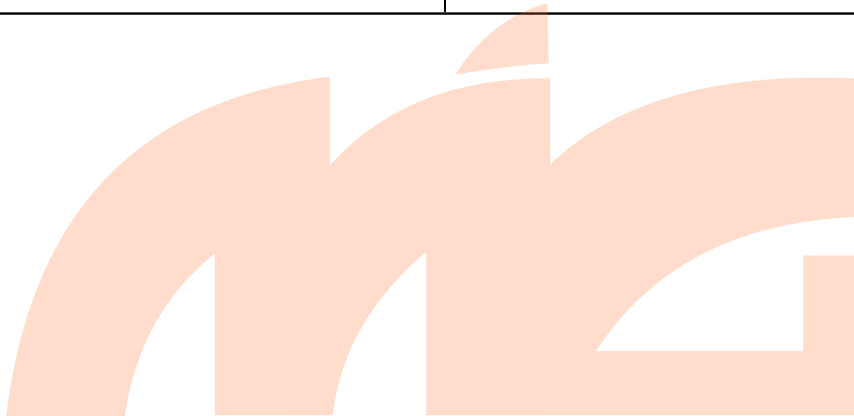

Threaded Rod

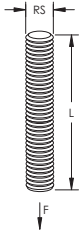
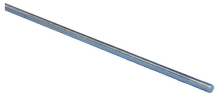

Material: Steel
 Tensile Strength: 58,000 psi
 Yield Strength: 36,000 psi

Part Number	Rod Size RS	Length L	Static Load F
Finish: Plain			
0503706PL	3/8"	6'	600 lb
0503710PL	3/8"	10'	610 lb
0503712PL	3/8"	12'	600 lb
Finish: Electrogalvanized			
0502506EG	1/4"	6'	240 lb
0502510EG	1/4"	10'	240 lb
0503706EG	3/8"	6'	600 lb
0503710EG	3/8"	10'	610 lb
0503712EG	3/8"	12'	600 lb
0505006EG	1/2"	6'	1,130 lb
0505010EG	1/2"	10'	1,130 lb
0505012EG	1/2"	12'	1,130 lb
0506206EG	5/8"	6'	1,810 lb
0506210EG	5/8"	10'	1,810 lb
0506212EG	5/8"	12'	1,810 lb
0507510EG	3/4"	10'	2,710 lb
0507512EG	3/4"	12'	2,710 lb
0508706EG	7/8"	6'	3,770 lb
0508710EG	7/8"	10'	3,770 lb

Load based on Max. 650 degrees F.

Strut Channel Type A, Slotted

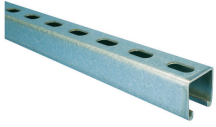

- Cold formed channel, slotted
- Strut channels for heavy applications
- For individual fastening or for efficiently constructing pipe or tube routes

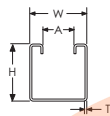
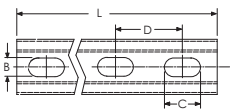

Part Number	Length L	Height H	Width W	Thickness T	A	B	C	D
Material: Steel – Finish: Hot-Dip Galvanized								
A12H1000HD	10'	1 5/8"	1 5/8"	12 GA	7/8"	9/16"	1 1/8"	2"
A12H2000HD	20'	1 5/8"	1 5/8"	12 GA	7/8"	9/16"	1 1/8"	2"
Material: Steel – Finish: Painted – Color: Green								
A12H1000GN	10'	1 5/8"	1 5/8"	12 GA	7/8"	9/16"	1 1/8"	2"
A14H1000GN	10'	1 5/8"	1 5/8"	14 GA	7/8"	9/16"	1 1/8"	2"
A12H2000GN	20'	1 5/8"	1 5/8"	12 GA	7/8"	9/16"	1 1/8"	2"
A14H2000GN	20'	1 5/8"	1 5/8"	14 GA	7/8"	9/16"	1 1/8"	2"
Material: Steel – Finish: Pregalvanized								
A12H1000PG	10'	1 5/8"	1 5/8"	12 GA	7/8"	9/16"	1 1/8"	2"
A14H1000PG	10'	1 5/8"	1 5/8"	14 GA	7/8"	9/16"	1 1/8"	2"
A12H2000PG	20'	1 5/8"	1 5/8"	12 GA	7/8"	9/16"	1 1/8"	2"
A14H2000PG	20'	1 5/8"	1 5/8"	14 GA	7/8"	9/16"	1 1/8"	2"
Material: Stainless Steel 304 [EN 1.4301]								
A12H1000S4	10'	1 5/8"	1 5/8"	12 GA	7/8"	9/16"	1 1/8"	2"

SK Single Piece Strut Clamp for Conduit



- One piece break apart strut clamp for EMT and Rigid conduit
- Includes thread impression and captured screw

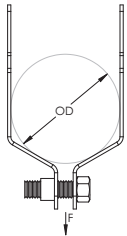

Part Number	EMT Conduit Size	Rigid Conduit/ Pipe Size	Outer Diameter OD	Width W	Static Load F	Certifications
Material: Aluminum						
SK8ALA	1/2"	1/2"	0.71" – 0.84"	1 1/4"	150 lb	-
SK12ALA	3/4"	3/4"	0.92" – 1.05"	1 1/4"	150 lb	-
SK16ALA	1"	1"	1.16" – 1.32"	1 1/4"	150 lb	-
SK20ALA	1 1/4"	1 1/4"	1.51" – 1.66"	1 1/4"	150 lb	-
SK24ALA	1 1/2"	1 1/2"	1.74" – 1.90"	1 1/4"	150 lb	-
SK32ALA	2"	2"	2.20" – 2.38"	1 1/4"	150 lb	-
Material: Steel – Finish: Electrogalvanized						
SK85I	1/2"	1/2"	0.71" – 0.84"	1 1/4"	200 lb	cULus
SK125I	3/4"	3/4"	0.92" – 1.05"	1 1/4"	200 lb	cULus
SK165I	1"	1"	1.16" – 1.32"	1 1/4"	200 lb	cULus
SK205I	1 1/4"	1 1/4"	1.51" – 1.66"	1 1/4"	200 lb	cULus
SK245I	1 1/2"	1 1/2"	1.74" – 1.90"	1 1/4"	200 lb	cULus
SK325I	2"	2"	2.20" – 2.38"	1 1/4"	200 lb	cULus
SK405I	2 1/2"	2 1/2"	2.88"	1 1/4"	350 lb	cULus
SK485I	3"	3"	3.50"	1 1/4"	350 lb	cULus
SK565I	3 1/2"	3 1/2"	4.00"	1 1/4"	350 lb	cULus
SK645I	4"	4"	4.50"	1 1/4"	350 lb	cULus

RIGD Single Piece Strut Clamp for Pipe/Rigid Conduit



- One piece break apart strut clamp (1/2" thru 4" pipe size)
- Includes thread impression and captured screw (1/2" thru 4" pipe size)
- Fits into open side of strut channel
- Conforms with Manufacturers Standardization Society (MSS) SP-58 (Type 59)

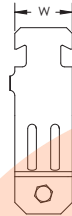
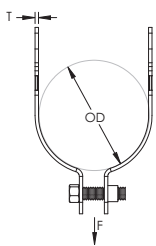

Part Number	Pipe Size	Outer Diameter OD	Width W	Thickness T	Static Load F
Material: Steel - Finish: Electrogalvanized					
RIGD0050EG	1/2"	0.840"	1 1/4"	14 GA	400 lb
RIGD0075EG	3/4"	1.050"	1 1/4"	14 GA	600 lb
RIGD0100EG	1"	1.315"	1 1/4"	14 GA	600 lb
RIGD0125EG	1 1/4"	1.660"	1 1/4"	14 GA	600 lb
RIGD0150EG	1 1/2"	1.900"	1 1/4"	12 GA	800 lb
RIGD0200EG	2"	2.375"	1 1/4"	12 GA	800 lb
RIGD0250EG	2 1/2"	2.875"	1 1/4"	12 GA	800 lb
RIGD0300EG	3"	3.500"	1 1/4"	12 GA	800 lb
RIGD0350EG	3 1/2"	4.000"	1 1/4"	11 GA	1,000 lb
RIGD0400EG	4"	4.500"	1 1/4"	11 GA	1,000 lb
Material: Stainless Steel 304 [EN 1.4301]					
RIGD0050S4	1/2"	0.840"	1 1/4"	14 GA	400 lb
RIGD0075S4	3/4"	1.050"	1 1/4"	14 GA	600 lb
RIGD0100S4	1"	1.315"	1 1/4"	14 GA	600 lb
RIGD0125S4	1 1/4"	1.660"	1 1/4"	14 GA	600 lb
RIGD0150S4	1 1/2"	1.900"	1 1/4"	12 GA	800 lb
RIGD0200S4	2"	2.375"	1 1/4"	12 GA	800 lb

Part Number	Pipe Size	Outer Diameter OD	Width W	Thickness T	Static Load F
RIGD0250S4	2 1/2"	2.875"	1 1/4"	12 GA	800 lb
RIGD0300S4	3"	3.500"	1 1/4"	12 GA	800 lb
RIGD0400S4	4"	4.500"	1 1/4"	11 GA	1,000 lb



Strut Cantilever Arm Type A, Slotted

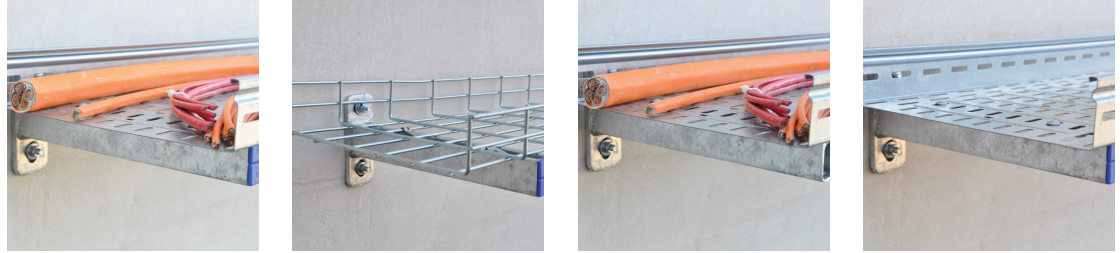

- Slotted channel
- Welded on flat mounting plate

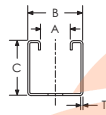
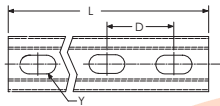
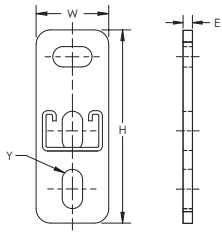

Material: Steel
Finish: Electrogalvanized

Part Number	Length L	Height H	Width W	Certifications
KA25H0150EG	6"	5 1/4"	2"	ITB
KA25H0300EG	11 7/8"	5 1/4"	2"	ITB
KA25H0450EG	17 3/4"	5 1/4"	2"	ITB
KA25H0600EG	23 5/8"	5 1/4"	2"	ITB

A	B	C	D	E	Y	Thickness T
7/8"	1 5/8"	1 5/8"	2"	5/16"	9/16" x 1 1/16"	0.098"

150M Standard U-Bolt

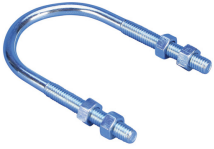

- Pipe support for general piping applications
- Comes complete with 4 nuts (2 installed on each end)
- Conforms with Federal Specification WW-H-171 (Type 24), Manufacturers Standardization Society ANSI®/MSS-SP-58 (Type 24)

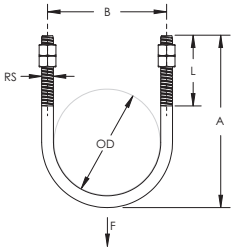

Part Number	Pipe Size	Outer Diameter OD	Rod Size RS	Screw Length L	A	B	Static Load F
Material: Steel - Finish: Plain							
150M0050PL	1/2"	0.840"	1/4"	2 3/8"	3 1/2"	1 1/16"	435 lb
150M0075PL	3/4"	1.050"	1/4"	2 3/8"	3 9/16"	1 5/16"	435 lb
150M0100PL	1"	1.315"	1/4"	2 3/8"	3 11/16"	1 9/16"	435 lb
150M0125PL	1 1/4"	1.660"	3/8"	2 3/8"	4 1/8"	2 1/16"	1,090 lb
150M0150PL	1 1/2"	1.900"	3/8"	2 1/2"	4 5/16"	2 1/4"	1,090 lb
150M0200PL	2"	2.375"	3/8"	2 1/2"	4 13/16"	2 3/4"	1,090 lb
150M0250PL	2 1/2"	2.875"	1/2"	3"	5 3/4"	3 3/8"	2,020 lb
150M0300PL	3"	3.500"	1/2"	3"	6 5/16"	4"	2,020 lb
150M0400PL	4"	4.500"	1/2"	3"	7 5/16"	5"	2,020 lb
150M0500PL	5"	5.563"	1/2"	3"	8 5/16"	6 1/16"	2,020 lb
150M0600PL	6"	6.625"	5/8"	3 3/4"	10 1/8"	7 1/4"	3,230 lb
150M0800PL	8"	8.625"	5/8"	3 3/4"	12 1/8"	9 1/4"	3,230 lb
150M1000PL	10"	10.750"	3/4"	4"	14 9/16"	11 1/2"	4,830 lb
150M1200PL	12"	12.750"	7/8"	4 1/4"	16 15/16"	13 5/8"	6,730 lb
150M1400PL	14"	14.000"	7/8"	4 1/4"	18 3/16"	14 7/8"	6,730 lb
150M1600PL	16"	16.000"	7/8"	4 1/4"	20 3/16"	16 7/8"	6,730 lb
150M1800PL	18"	18.000"	1"	4 3/4"	22 11/16"	19"	8,850 lb
Material: Steel - Finish: Electrogalvanized							
150M0050EG	1/2"	0.840"	1/4"	2 3/8"	3 1/2"	1 1/16"	435 lb
150M0075EG	3/4"	1.050"	1/4"	2 3/8"	3 9/16"	1 5/16"	435 lb
150M0100EG	1"	1.315"	1/4"	2 3/8"	3 11/16"	1 9/16"	435 lb
150M0125EG	1 1/4"	1.660"	3/8"	2 3/8"	4 1/8"	2 1/16"	1,090 lb
150M0150EG	1 1/2"	1.900"	3/8"	2 1/2"	4 5/16"	2 1/4"	1,090 lb
150M0200EG	2"	2.375"	3/8"	2 1/2"	4 13/16"	2 3/4"	1,090 lb
150M0250EG	2 1/2"	2.875"	1/2"	3"	5 3/4"	3 3/8"	2,020 lb

Part Number	Pipe Size	Outer Diameter OD	Rod Size RS	Screw Length L	A	B	Static Load F
150M0300EG	3"	3.500"	1/2"	3"	6 5/16"	4"	2,020 lb
150M0400EG	4"	4.500"	1/2"	3"	7 5/16"	5"	2,020 lb
150M0500EG	5"	5.563"	1/2"	3"	8 5/16"	6 1/16"	2,020 lb
150M0600EG	6"	6.625"	5/8"	3 3/4"	10 1/8"	7 1/4"	3,230 lb
150M0800EG	8"	8.625"	5/8"	3 3/4"	12 1/8"	9 1/4"	3,230 lb
150M1000EG	10"	10.750"	3/4"	4"	14 9/16"	11 1/2"	4,830 lb
150M1200EG	12"	12.750"	7/8"	4 1/4"	16 15/16"	13 5/8"	6,730 lb
150M1400EG	14"	14.000"	7/8"	4 1/4"	18 3/16"	14 7/8"	6,730 lb
150M1600EG	16"	16.000"	7/8"	4 1/4"	20 3/16"	16 7/8"	6,730 lb
150M1800EG	18"	18.000"	1"	4 3/4"	22 11/16"	19"	8,850 lb
Material: Steel – Finish: Hot-Dip Galvanized							
150M0075HD	3/4"	1.050"	1/4"	2 3/8"	3 9/16"	1 5/16"	435 lb
150M0100HD	1"	1.315"	1/4"	2 3/8"	3 11/16"	1 9/16"	435 lb
150M0125HD	1 1/4"	1.660"	3/8"	2 3/8"	4 1/8"	2 1/16"	1,090 lb
150M0150HD	1 1/2"	1.900"	3/8"	2 1/2"	4 5/16"	2 1/4"	1,090 lb
150M0200HD	2"	2.375"	3/8"	2 1/2"	4 13/16"	2 3/4"	1,090 lb
150M0250HD	2 1/2"	2.875"	1/2"	3"	5 3/4"	3 3/8"	2,020 lb
150M0300HD	3"	3.500"	1/2"	3"	6 5/16"	4"	2,020 lb
150M0400HD	4"	4.500"	1/2"	3"	7 5/16"	5"	2,020 lb
150M0500HD	5"	5.563"	1/2"	3"	8 5/16"	6 1/16"	2,020 lb
150M0600HD	6"	6.625"	5/8"	3 3/4"	10 1/8"	7 1/4"	3,230 lb
150M0800HD	8"	8.625"	5/8"	3 3/4"	12 1/8"	9 1/4"	3,230 lb
150M1000HD	10"	10.750"	3/4"	4"	14 9/16"	11 1/2"	4,830 lb
150M1200HD	12"	12.750"	7/8"	4 1/4"	16 15/16"	13 5/8"	6,730 lb
150M1400HD	14"	14.000"	7/8"	4 1/4"	18 3/16"	14 7/8"	6,730 lb
150M1600HD	16"	16.000"	7/8"	4 1/4"	20 3/16"	16 7/8"	6,730 lb
Material: Stainless Steel 304 [EN 1.4301]							
150M0050S4	1/2"	0.840"	1/4"	2 3/8"	3 1/2"	1 1/16"	435 lb
150M0075S4	3/4"	1.050"	1/4"	2 3/8"	3 9/16"	1 5/16"	435 lb
150M0100S4	1"	1.315"	1/4"	2 3/8"	3 11/16"	1 9/16"	435 lb
150M0125S4	1 1/4"	1.660"	3/8"	2 3/8"	4 1/8"	2 1/16"	1,090 lb
150M0150S4	1 1/2"	1.900"	3/8"	2 1/2"	4 5/16"	2 1/4"	1,090 lb
150M0200S4	2"	2.375"	3/8"	2 1/2"	4 13/16"	2 3/4"	1,090 lb
150M0250S4	2 1/2"	2.875"	1/2"	3"	5 3/4"	3 3/8"	2,020 lb
150M0300S4	3"	3.500"	1/2"	3"	6 5/16"	4"	2,020 lb
150M0400S4	4"	4.500"	1/2"	3"	7 5/16"	5"	2,020 lb
150M0500S4	5"	5.563"	1/2"	3"	8 5/16"	6 1/16"	2,020 lb
150M0600S4	6"	6.625"	5/8"	3 3/4"	10 1/8"	7 1/4"	3,230 lb
150M0800S4	8"	8.625"	5/8"	3 3/4"	12 1/8"	9 1/4"	3,230 lb
150M1000S4	10"	10.750"	3/4"	4"	14 9/16"	11 1/2"	4,830 lb
150M1200S4	12"	12.750"	7/8"	4 1/4"	16 15/16"	13 5/8"	6,730 lb
150M1400S4	14"	14.000"	7/8"	4 1/4"	18 3/16"	14 7/8"	6,730 lb
150M1600S4	16"	16.000"	7/8"	4 1/4"	20 3/16"	16 7/8"	6,730 lb

nVent CADDY EZ Riser



- One-piece hinge design comes out of the box ready to install
- Lack of loose hardware eliminates dropped or lost components, eliminating potential rework and speeding up installation
- Carriage bolts seat into clamp, eliminating the need for multiples tools when tightening
- Installs up to 60% faster than standard riser clamps and 45% faster than the industry-leading first generation EZ Riser
- Multi-functional clamp can be installed in several approved orientations, simplifying material handling
- Integrated second set of bolt holes allow the assembly to easily adapt from a riser clamp into a stand-off support
- In spaces where full-sized riser clamps do not fit, integrated score marks allow for easy removal of ears
- Retains listing when the ears are removed for close quarters, uniquely making the nVent CADDY EZ Riser capable of a listing in both installations
- Recommended for suspending vertical steel pipe risers
- No need to stock and use separate part families for standard and close quarter clamps to offer a full range of listed parts, reducing inventory by 38%
- Conforms with Federal Specification WW-H-171 (Type 8), Manufacturers Standardization Society (MSS) SP-58 (Type 8)

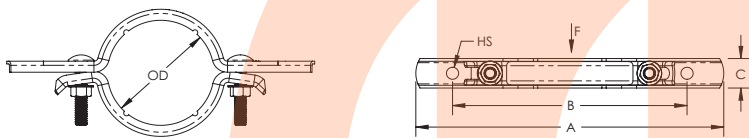

Material: Steel
Finish: Electrogalvanized



Part Number	Pipe Size	Outer Diameter OD	Hole Size HS	A	B	C	Static Load F
EZR0050	1/2"	0.840"	0.39"	8 1/2"	5 1/8"	7/8"	255 lb
EZR0075	3/4"	1.050"	0.39"	9"	5 3/8"	7/8"	255 lb
EZR0100	1"	1.315"	0.39"	9"	5 5/8"	7/8"	255 lb
EZR0125	1 1/4"	1.660"	0.39"	9 1/2"	6"	7/8"	255 lb
EZR0150	1 1/2"	1.900"	0.39"	9 7/8"	6 1/4"	7/8"	255 lb
EZR0200	2"	2.375"	0.39"	10 1/4"	7"	1"	255 lb
EZR0250	2 1/2"	2.875"	0.39"	11"	7 1/2"	1"	390 lb
EZR0300	3"	3.500"	0.39"	11 3/4"	8 1/8"	1"	530 lb
EZR0350	3 1/2"	4.000"	0.52"	12 5/8"	9 3/8"	1 1/4"	670 lb
EZR0400	4"	4.500"	0.52"	13"	10"	1 1/4"	810 lb
EZR0500	5"	5.563"	0.52"	14 1/2"	11 3/4"	1 1/2"	1,160 lb
EZR0600	6"	6.625"	0.52"	16"	12 3/4"	1 1/2"	1,570 lb

Clamp is fitted for steel pipe and should be installed below a coupling or shear lug, with bolts torqued to recommended value. Use of a socket or driver is recommended for installation.



Telescoping Pipe Stand



- Supports and fastens low to the ground horizontal pipe runs
- Complete out-of-the-box assembly provides a compact solution, simplifying material handling and reducing the amount of storage space required
- Designed to minimize fabrication and reduce the installation time of a complete stand by up to 80%
- Telescoping post provides fast vertical height adjustment
- V-bolt fastener accommodates multiple pipe sizes, reducing inventory by over 65%
- Easy "push-to-install" nVent CADDY Rod Lock feature allows the V-bolt to assemble quickly
- Integrated weep hole at bottom of stand provides drainage for condensation
- Includes four holes for anchoring base to floor
- Conforms with Federal Specification WW-H-171 (Type 37, 38), Manufacturers Standardization Society ANSI®/MSS-SP-58 (Type 37)

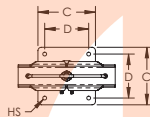
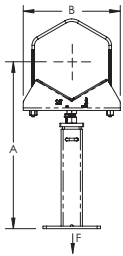

Material: Steel
 Finish: Electrogalvanized
 Static Load Safety Factor: 3.5:1

Part Number	Pipe Size	A	B	C	D	Hole Size HS	Static Load F
CTS04	1" – 8"	20" – 40 1/2"	6 1/2"	6 1/2"	5"	9/16"	1,370 lb
CTS10	5" – 24"	23" – 49 7/8"	14 3/8"	8 1/2"	6 1/2"	9/16"	1,740 lb

Part Number	Pipe Size	A
CTS04	1"	20" – 36 1/4"
	1 1/4"	20 1/4" – 36 1/2"
	1 1/2"	20 3/8" – 36 5/8"
	2"	20 5/8" – 36 7/8"
	3"	21 1/4" – 37 1/2"
	4"	21 7/8" – 38 1/8"
	5"	22 1/2" – 38 3/4"
	6"	23 1/8" – 39 1/4"
	8"	24 1/4" – 40 1/2"

Part Number	Pipe Size	A
CTS10	5"	23" - 39 1/4"
	6"	23 1/2" - 40"
	8"	24 3/4" - 41"
	10"	26" - 42 1/4"
	12"	27 1/4" - 43 3/8"
	14"	27 7/8" - 44 1/8"
	16"	29 1/8" - 45 1/4"
	18"	30 1/4" - 46 3/8"
	20"	31 3/8" - 47 1/2"
	24"	33 5/8" - 49 7/8"

When insulating pipe install V-bolt after insulation.

CTS04 can accommodate pipe sizes from 1" through 4" when v-bolt is used. CTS10 can accommodate pipe sizes from 5" through 10" when v-bolt is used.

Installer must determine weight of the pipe and proper spacing when supporting larger sizes.



ANSI is a registered trademark of American National Standards Institute. FM is a registered certification mark of FM Approvals LLC, LTD. HangerMate is a registered trademark of Acument Intellectual Properties, LLC. NFPA is a registered trademark of National Fire Protection Association, Inc. UL, UR, cUL, cUR, cULus and cURus are registered certification marks of UL LLC. VdS is a registered trademark of VdS Schadenverhütung GmbH.

WARNING

nVent products shall be installed and used only as indicated in nVent's product instruction sheets and training materials. Instruction sheets are available at www.erico.com and from your nVent customer service representative. Improper installation, misuse, misapplication or other failure to completely follow nVent's instructions and warnings may cause product malfunction, property damage, serious bodily injury and death and/or void your warranty.

© 2019 nVent All rights reserved

nVent, nVent CADDY, nVent ERICO, nVent ERIFLEX and nVent LENTON are owned by nVent or its global affiliates.

All other trademarks are the property of their respective owners. nVent reserves the right to change specifications without prior notice.

